

# **MMS3000-T6V4**

## **Owner's Manual**

**Revision 270201**

## Trademark Notice

Multi Measurement System™, MMS™, T6V4™, MM3000-T6V4™, MAS™, and **PROFLASH™ are trademarks of** COMMTEST INSTRUMENTS Ltd.

Other trademarks and registered trademarks belong to their respective owners.

**©COPYRIGHT – 2001** COMMTEST INSTRUMENTS Ltd.

All Rights Reserved

# CONTENTS

<b>INTRODUCTION.....</b>	<b>7</b>
<b>1.1 STANDARD FEATURES.....</b>	<b>8</b>
<b>1.2 STANDARD KIT ITEMS .....</b>	<b>9</b>
<b>1.3 SUMMARY OF PARTS.....</b>	<b>10</b>
<b>1.4 PRECAUTIONS .....</b>	<b>11</b>
<b>1.5 USING THIS MANUAL .....</b>	<b>13</b>
1.5.1 Warnings.....	13
1.5.2 Names.....	13
1.5.3 Instruction Sequences .....	14
1.5.4 Instruction Types .....	14
<b>BASIC OPERATION.....</b>	<b>15</b>
<b>2.1 GENERAL .....</b>	<b>16</b>
2.1.1 Powering Up .....	16
2.1.2 Accessing Main Menu.....	16
2.1.3 Selecting a Main Menu Item .....	17
2.1.4 Selecting an Option .....	17
2.1.5 Editing Names .....	19
2.1.6 Editing Numerical Values.....	22
<b>2.2 SETTING UP INPUTS.....</b>	<b>23</b>
2.2.1 Channel Selection & Setup.....	24
2.2.2 Channel Types.....	25
2.2.3 Matching Inputs to Sensors .....	26
2.2.4 Modifying the Input boxes.....	27
2.2.5 Editing the Input Value:.....	27
2.2.6 Sampling the Input value: .....	28
2.2.7 Modifying the Output boxes.....	29
2.2.8 Modifying the Units .....	29
<b>2.3 SETTING UP CHANNELS.....</b>	<b>30</b>
2.3.1 Setting Up Your Recording (The Trigger Menu).....	30
2.3.2 Setting Display Options .....	36
2.3.3 Graph Controls .....	37
<b>2.4 RECORDING DATA .....</b>	<b>39</b>
2.4.1 Setting Up the Filename .....	39

2.4.2	Choosing a Folder .....	39
2.4.3	Starting a Recording .....	40
2.4.4	Auto-Repeating Recordings.....	40
2.4.5	Chained Recordings .....	41
<b>2.5</b>	<b>PLAYING BACK.....</b>	<b>42</b>
<b>2.6</b>	<b>FILE UTILITIES .....</b>	<b>43</b>
<b>2.7</b>	<b>OUTPUTTING SAMPLES FROM RS232.....</b>	<b>44</b>
<b>UTILITIES</b>	<b>.....</b>	<b>45</b>
<b>3.1</b>	<b>RESETTING THE INSTRUMENT .....</b>	<b>46</b>
<b>3.2</b>	<b>ADJUSTING LCD .....</b>	<b>47</b>
3.2.1	Adjusting Contrast .....	47
3.2.2	Turning Backlight On .....	47
<b>3.3</b>	<b>SETTING CLOCK.....</b>	<b>48</b>
3.3.1	Checking Date and Time .....	48
3.3.2	Setting Date and Time .....	48
<b>3.4</b>	<b>MANAGING BATTERY .....</b>	<b>49</b>
3.4.1	Instrument Battery .....	49
3.4.2	Checking Battery Capacity .....	50
3.4.3	Charging Powered-up instrument.....	50
3.4.4	Charging Powered-down instrument .....	50
3.4.5	Reconditioning Battery Pack.....	51
3.4.6	Power Saver .....	51
3.4.7	Replacing Battery Pack .....	52
<b>3.5</b>	<b>ERASING MEMORY.....</b>	<b>53</b>
<b>3.6</b>	<b>TROUBLESHOOTING.....</b>	<b>54</b>
3.6.1	Power Problems .....	54
3.6.2	Data Problems .....	54
3.6.3	Data-Transfer Problems .....	55
3.6.4	Other Problems.....	55
<b>ANALYSIS SOFTWARE</b>	<b>.....</b>	<b>57</b>
<b>4.1</b>	<b>INSTALLING MAS-3000.....</b>	<b>58</b>
4.1.1	License Agreement.....	58
4.1.2	PC System Requirements .....	58
4.1.3	Installing MAS on PC.....	59
<b>4.2</b>	<b>STARTING UP MAS.....</b>	<b>60</b>

4.2.1 Starting up .....	60
4.2.2 Configuring PC COM port.....	60
<b>4.3 TRANSFERRING DATA TO THE PC .....</b>	<b>61</b>
<b>4.4 MANAGING DATA .....</b>	<b>62</b>
4.4.1 Opening a File .....	62
4.4.2 Merging Two Files .....	62
4.4.3 Using the Navigator .....	62
4.4.4 Deleting Data from a Folder.....	62
4.4.5 Editing Recording Details .....	63
4.4.6 Viewing and Printing Data .....	63
4.4.7 Exporting data.....	64
<b>4.5 CALCULATING DATA .....</b>	<b>65</b>
<b>4.6 PLOTTING DATA .....</b>	<b>66</b>
4.6.1 Plotting Single and Individual Charts.....	66
4.6.2 Zooming & Panning .....	67
4.6.3 Printing Charts .....	67
4.6.4 Reading and Comparing Values.....	68
4.6.5 Plotting Waterfall Charts.....	70
<b>4.7 UPGRADING FIRMWARE.....</b>	<b>71</b>
<b><i>Appendix SPECIFICATIONS.....</i></b>	<b><i>73</i></b>
<b><i>Appendix Application Notes .....</i></b>	<b><i>75</i></b>
6.1 Application Note 1.....	75
6.2 Application Note 2.....	80
<b><i>Appendix Optimizing Temperature Accuracy.....</i></b>	<b><i>83</i></b>
<b><i>Appendix MAS-3000 MATH.....</i></b>	<b><i>85</i></b>
<b>8.1 FUNCTIONS .....</b>	<b>86</b>
8.1.1 Mathematical Functions.....	86
8.1.2 Iterative Functions .....	88
8.1.3 Logical Functions.....	88
8.1.4 Conditional Functions .....	89
8.1.5 Date and Time Functions.....	89
<b>8.2 OPERATORS .....</b>	<b>90</b>
8.2.1 Logical Operators .....	90
8.2.2 Arithmetic Operators.....	90





# INTRODUCTION

Congratulations on purchasing the T6V4.

The T6V4 allows up to six channels of **temperature** measurement ranging from  $-250$  to  $+1370^{\circ}\text{C}$  ( $-418$  to  $+2498^{\circ}\text{F}$ ) depending on the thermocouple type, and up to four channels of **voltage** measurement with user-selectable settings of  $\pm 5\text{VDC}$  or  $\pm 30\text{VDC}$ . Collected data can be transferred to a PC where it can be analyzed in detail using the MAS Windows<sup>®</sup>-based software supplied in the kit.

This manual has been formatted to allow you to quickly learn how to use your T6V4. Please keep this manual for future reference and read it before operating your T6V4.

# 1.1 STANDARD FEATURES

- 24-bit A/D converter providing high-precision measurements
- 512kB non-volatile memory capable of storing up to 400,000 sample points
- Time- and date-stamped recordings
- Temperature-compensated graphical LCD (liquid-crystal display) with 240x128 pixels
- Electro-luminescent LCD backlight
- Built-in battery charger and conditioner
- 1500mAh Ni-Cad (Nickel-Cadmium) battery pack
- Upgradeable firmware
- RS232 interface to communicate with a PC (personal computer)
- Windows® based Measurement Analysis Software (MAS)

# 1.2 STANDARD KIT ITEMS



**MMS3000 Series** instrument with protective boot and strap

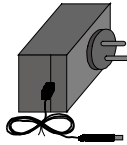

AC/DC power transformer  
13.5± 1.5VDC, 1A output

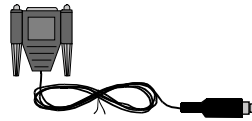

Data-transfer cable with DB9 connector



Quality assurance card

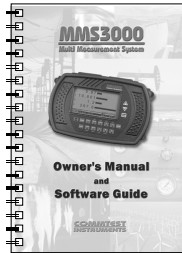

**MMS3000 Series**  
Owner's Manual and Software Guide



**MAS-3000**  
analysis software CD

# 1.3 SUMMARY OF PARTS

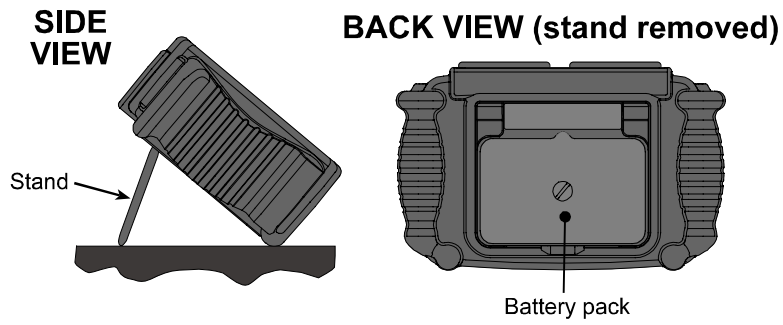
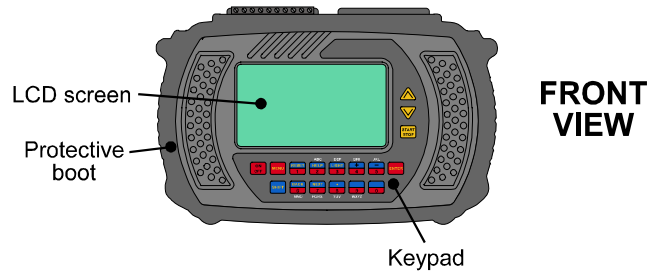
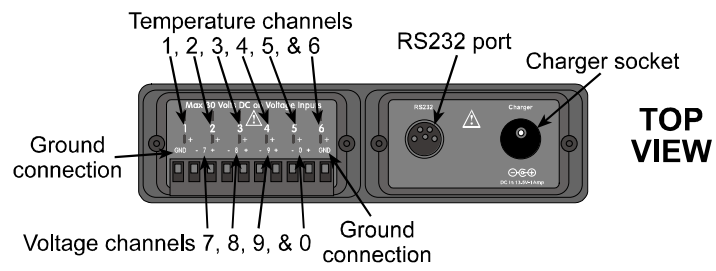

# 1.4 PRECAUTIONS

**WARNING:** Please read and understand this section fully before operating your instrument. Not heeding the warnings or recommendations could result in data loss, data inaccuracy, damage to the instrument, or injury to yourself.

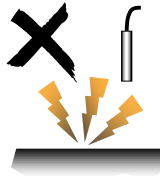

**WARNING:** To avoid electrical shock, do not connect any sensor to a high voltage i.e. a voltage that exceeds 50VDC or 32VAC or the “safety extra low voltage” (SELV) defined by your local power authority.

**WARNING:** Ensure the data-transfer cable and bootstrap cannot be entangled with any moving or rotating machinery.

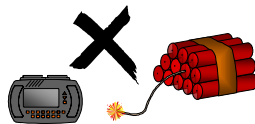
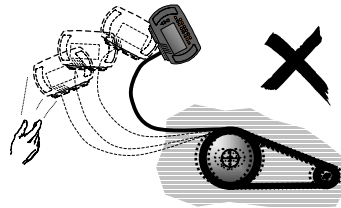

**WARNING:** Do not operate the instrument in an explosive environment.

**WARNING:** Do not detach the battery pack from the instrument for more than 2 hours as data and settings may be lost.

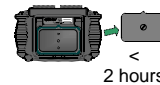

**WARNING:** Transfer data stored in the instrument to a PC before **PROFLASHing** the instrument with new firmware – reprogramming the instrument erases all data stored in the instrument (see section 4.6).

**WARNING:** Charge the battery pack up to at least 30% capacity before taking a recording. If using the instrument for 4 hours or more, first ensure that the battery pack is fully charged.

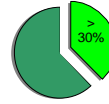

**WARNING:** Constantly charging the battery when it is not fully drained will create a "Memory" effect and eventually shorten the amount of charge that the battery can hold. Please read **3.4 Managing Battery** to learn how to prevent this.



**WARNING:** Do not expose the instrument to large impacts or pressure.

**WARNING:** Do not use alcohol or any organic solvent to clean the instrument.



**WARNING:** Do not expose the instrument to wet conditions or store it in a damp place where the relative humidity exceeds 80% RH.

**WARNING:** Do not place the instrument in a hot place where the temperature exceeds 140°F (60°C). Otherwise, the battery pack will degrade.

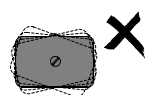

**WARNING:** Ensure that the battery pack is securely fastened – but not over-tightened – to the instrument before operating the instrument.

**WARNING:** If the instrument malfunctions, return it to an authorized dealer. Do not try to repair it yourself, as this will invalidate the warranty.

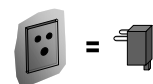

**WARNING:** Use only an approved power transformer and ensure its voltage and frequency rating matches that of your mains AC power.

# 1.5 USING THIS MANUAL

## 1.5.1 Warnings

In this manual, the word **WARNING** is displayed where certain actions may lead to damaging consequences. Please heed all such warnings.

## 1.5.2 Names

In this manual, window and screen names are *italicized*. These names refer to the names appearing at the top of windows/screens.

*MAS Window*

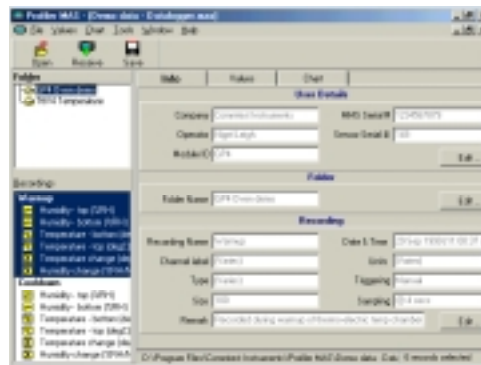

The PC key names are shown as normal text, e.g. Shift refers to the Shift key on the PC keyboard.

Keys on the instrument are shown as they appear on the instrument keypad, e.g.  refers to the Shift key on the instrument.

Some instrument keys have more than one function, e.g. the  key which is used as either the *ON* key or the *OFF* key depending on the state the instrument is operating in.

### 1.5.3 Instruction Sequences

The ▶ symbol is used to indicate the sequence of menu selections.

Instruction	Meaning
Click <i>File</i> ▶ <i>Save</i> .	Select the <i>File</i> menu and then select <i>Save</i> .

### 1.5.4 Instruction Types

The word “press” refers to key presses or menu selections on the instrument.

The word “click” refers to menu selections on the PC, and “push” refers to key presses on the PC keyboard.

Instruction	Meaning
Click <i>File</i> ▶ <i>Export</i> .	Select <i>File</i> and then <i>Export</i> in MAS-3000 software.
Push the Esc key.	Push the Esc key on the PC keyboard.

Some operating instructions are illustrated with examples. Such instructions are marked with the word **EXAMPLE**.

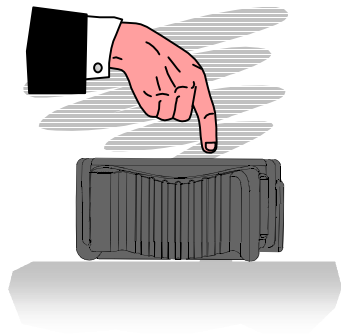

# BASIC OPERATION



This section outlines the procedure for performing basic operations on your instrument. You will learn to:

- use the instrument menu system;
- record data; and
- playback recorded data.

**WARNING:** Read section 1.4 before operating your instrument.

## 2.1 GENERAL



### 2.1.1 Powering Up\*

- Press . The *Initialization* screen is displayed.
- Press . Measurement begins and the screen displays data that is being measured (using previous settings).
- To power down, press  and follow on-screen instructions. If the instrument does not respond to any key press, reset it (see section 3.1).

### 2.1.2 Accessing Main Menu

To perform instrument operations, you need to access the main menu. To access the main menu:

- Press .

You can alternatively press . The main menu is displayed at the top of the screen and consists of four items: *File*, *Display*, *Trig(ger)*, and *Sys(tem)*. To cancel the main menu, press  again.







---

\* Every time the instrument is powered up, the power saver (a power-saving feature) is automatically turned on. See section 3.4.6 for more details.

### 2.1.3 Selecting a Main Menu Item

- Press the number preceding the menu item.

Alternatively, press  and  to cycle to the menu item then press  or .





**EXAMPLE:** to select the main menu item *Trig*, press .





The drop down menu above shows the available options for the *Trigger* menu. To cancel a dropdown menu, press .

### 2.1.4 Selecting an Option

The procedure for selecting an option in a dropdown menu is similar to selecting a main menu item i.e.

- Press the number preceding the option, or press  and  to cycle to the option and then press  or .

Selected options, where appropriate, are checked (✓). Selecting options with “...” brings up windows that provide more options. These options, and any further options they provide, can be selected in the same manner. Most windows have self-explanatory instructions. If more than one window is displayed, the topmost is the one active. To cancel a window, press .

**EXAMPLE:** to select *Level Based...* in the example below, press 

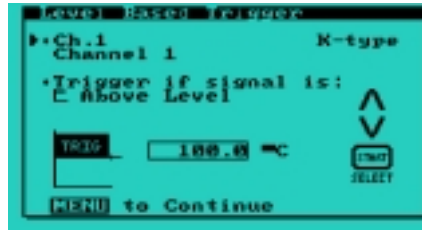

## 2.1.5 Editing Names

To enter characters in the text editing window:

- Select *Display* from the main menu and then select *Edit Channel Units* or *Edit Channel Names*.
- Press the key with the character you want until it appears above the flashing cursor.

e.g. to enter the letter B, press  until the B is displayed.





- The cursor advances automatically when you press the next key.

e.g. if the next letter you want to enter is E, press  until E is displayed.



- If the next letter of the word is on the same key just pressed, press  to advance the cursor position.



e.g. press  then press key  until the letter D appears. (The cursor can be moved backwards by pressing ).





- More editing options (and their shortcut keys) are available by pressing .

**Note:**  and  can be used to enter the space character.

Libraries are available to make entering text easier.

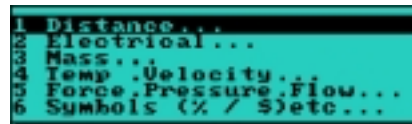

















- Press   to access the library categories.



- Pressing   will show the last text library selected.











**Table of Short Cut Keys**

Short Cut Key	Meaning
 	Clear all text
  or 	Move cursor forward
  or 	Move cursor back
 	Insert a space
 	Delete character
 or  (press twice)	Can be used to enter a space
 	Text Library
 	Last Text Library

To toggle from upper to lower case press  and choose the desired case from the pop-up menu.

Folder, Recording and Channel names can have a maximum of 16 characters. Unit Names can have a maximum of 8 characters.

## 2.1.6 Editing Numerical Values

- Select the numeric field to be edited (using the normal option selection procedure outlined in section 2.1.4).
- Press the appropriate digit keys to enter the desired value. Enter a decimal point by pressing  .
- To make the number negative/positive press  .
- Clear floating point numbers by pressing  . Non-floating point numbers can sometimes be incremented or decremented by pressing  or , e.g. This is possible when setting the SAMPLING PERIOD.

## 2.2 SETTING UP INPUTS

The T6V4 module is capable of simultaneous measurements of up to eight channels of data at a time. Due to the sharing of channels 5 and 9, and of channels 6 and 0, the following conditions apply:

- Channels 5 and 9 cannot be simultaneously selected
- Channels 6 and 0 cannot be simultaneously selected

### WARNING

1. Ensure that when using these shared channels, that only the selected sensor type is connected. If a voltage source and thermocouple of shared channels are simultaneously connected, measurements will be erroneous.
2. Never allow voltages of more than 10V between any two thermocouple inputs, or 5V between an input and module ground. This may damage the instrument.
3. Thermocouple channels 5 and 6 have a low input impedance due to the fact that they are shared with voltage channels 9 and 0. If thermocouples of a resistance higher than a few Ohms (eg. Thermocouples with wire lengths longer than typically 2 to 3 meters) are used in these channels a small error will be introduced. This error is proportional to the ratio of the thermocouple resistance to the input impedance.
4. For best accuracy, all sources being measured should be perfectly isolated from each other (including thermocouple inputs)<sup>†</sup>.

---

<sup>†</sup> See appendix 3 for more details.

## 2.2.1 Channel Selection & Setup

The instrument needs to know what type of sensor is attached to each input channel. You must set up the input channels one at a time.

- Access the main menu (see section 2.1.2).
- Press *Sys* ▶ *Setup Inputs...* to display the “Setup Channel Input” window.

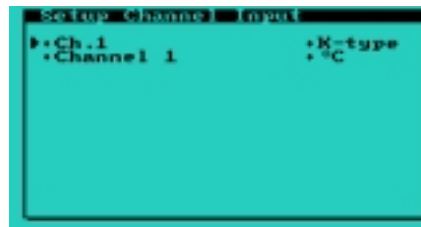

- Press **ENTER** or **START/STOP** to display the channel drop down menu.

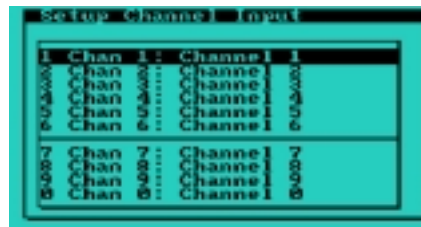

- Select the channel you would like to setup.

**Note:** Channels can be named by choosing “*Edit/Names*” from the “*Display*” menu on the main menu bar (see section 2.1.2). These names appear when downloading to a PC.

## 2.2.2 Channel Types

There are two types of channels on the instrument, temperature and voltage. Each type of channel has different configuration options as follows:

### Temperature Channels

Thermocouple type can be selected

- This can be done by moving the cursor to the “K-type” option in the “Setup Channel Input” window and pressing **ENTER** or **START/STOP**. The following screen will be displayed.

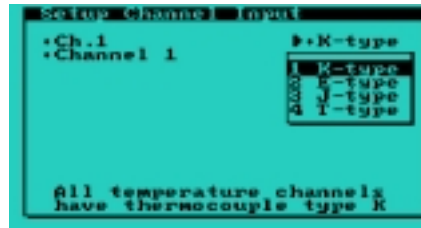

- All thermocouples attached to the instrument must be of the same type.

Units can be selected

- Move the cursor to the units displayed below the thermocouple type and press **ENTER** or **START/STOP** to cycle through the units, “C”, “F”, and “User”.

### Voltage Channels

Voltage range can be selected

- Move the cursor to the “+/- 30V” and pressing **ENTER** or **START/STOP** will toggle between “+/- 30V” and “+/- 5V”.

Any change made to the voltage range will reset the input and output ranges to the default setup values.

## 2.2.3 Matching Inputs to Sensors

If you are using standard thermocouple or voltage inputs, then no further setup is required. However for using other sensors, you need to match the inputs from the sensor to the values you would like displayed.

**EXAMPLE:** If you have a 0V – 24V proximity probe connected to channel 8 that outputs:

0V at 1 mm  
and 24V at 3.4 mm



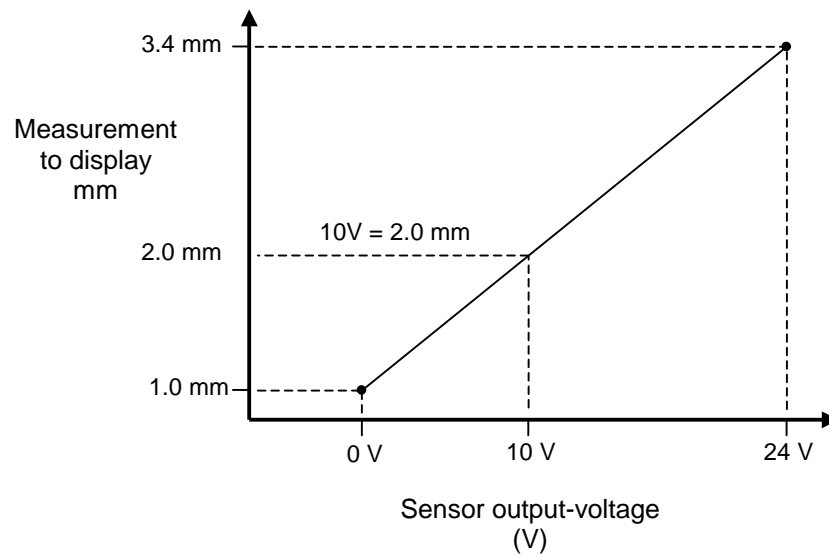

then the following linear relationship is assumed:



## 2.2.4 Modifying the Input boxes



In this example we will setup the channel to match the following sensor inputs:

Input	Output	Units
0.000 V	1.0	mm
24.000 V	3.0	mm

- From the main menu, press **Sys** ▶ **Setup Inputs...** and select the channel to be setup.
- Use the  or  arrows to move the flashing cursor to the input box you wish to edit.
- Press  or  to display a list of edit options.



## 2.2.5 Editing the Input Value:

- Select “*Edit Input...*” to enter the sensor input voltage in V.
- Press  or  to accept the entered value.

## 2.2.6 Sampling the Input value:

It is also possible to set the input boxes by sampling the voltage or temperature being monitored by the instrument.

This is very useful if you know what you're measuring, but do not know what voltage / temperature your input sensor is providing.

e.g.

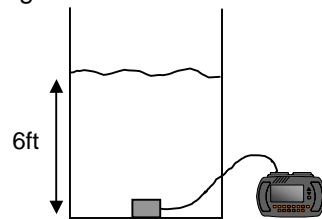

You have a sensor that can measure the depth of water based on pressure readings but have no data that relates the sensor output voltage to the actual depth. However, you do know that the present depth = 6ft.







- To match the input box follow the steps from the previous example, but choose “*Sample Input*”.







- The input box will update with the sample taken being displayed in the selected input box.
- If you are not happy with the sampled value keep selecting “*Sample Input*” until you are, then press **MENU** to close the options menu.

- Note:**
- The first input box reading must be lower than the second input box.
  - Input box readings must be more than 50° apart for temperature and more than 1V apart for voltage.

## 2.2.7 Modifying the Output boxes

- Use the  or  arrows to move the flashing cursor to the output box to be altered.
- Press  or  to edit the value in this box. The box will become highlighted, with its previous value cleared. Now enter in the value, and press  or  to accept this value.





- Now press  arrow to select the next output box (The cursor should flash beneath it).
- Press  to begin editing. Type in the number 3.4, and press  or  to accept this value.



- Note:** Output box values
- Can be positive or negative.
  - Can contain decimal places.
  - Can be in any order (i.e. box 1 can be greater than box 2).

## 2.2.8 Modifying the Units

- To change the units (e.g. to mm), press  arrow until two flashing cursors appear below the unit boxes.
- Press  to begin editing the unit. The “Enter Channel Unit” window will appear (see section 2.1.5).

## 2.3 SETTING UP CHANNELS

### 2.3.1 Setting Up Your Recording (The Trigger Menu)

Most of the important information involved in your recording is entered under the trigger menu. Trigger Type, which Channels are enabled, Sample Period, and Recording length/time.

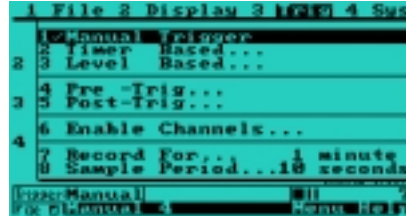

Below are examples of all the trigger menu items. Each item can be configured by following the pop-up menus as per previous sections. Timer and level based trigger options can be selected by the ▲ or ▼ arrows and pressing ENTER or START/STOP.

The Trigger Type (how recordings are started).

There are three main types of trigger available:

- **Manual Trigger**
- **Time Based Trigger**
- **Level Based Trigger**

1 **Manual Trigger** - recording started and stopped by pressing  button.

2 **Timer Based Trigger** - data is recorded at regular intervals.

- e.g.
- Log data every day
  - Starting at 10:05:00am
  - Record 5 samples
  - Sample Period = 1 second
  - After Recording Power Down (30 sec sensor warm up)
- } *Log Period*
- } *Recording Period*
- } *Sampling Period*
- } *Stay Awake or Power Down and Warm Up Instructions*

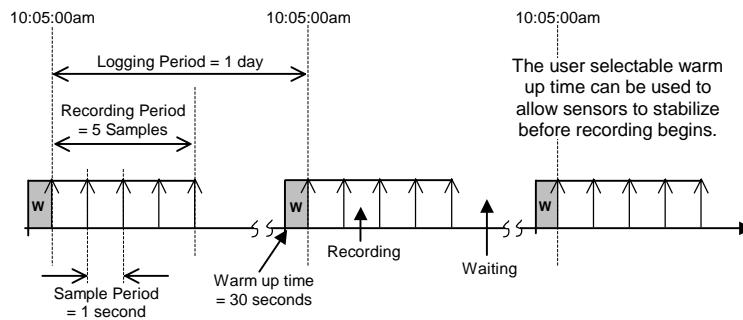

- 3 **Level Based Trigger** - data is recorded if a sensor reaches a specified level.

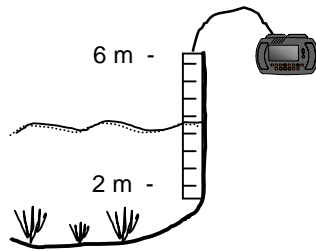

e.g. Trigger if lake level is above 6m or below 2m.



(Outside Window Level)

Available level trigger options.



Trigger if signal is: Above Below Inside Outside Level(s)

The Level based triggering option also allows for two more types of triggering to be used:

- **Pre-Triggering**
- **Post-Triggering**

- 4 **Pre-Trigger** - record data for a specified time before a level trigger occurs (level trigger must also be selected).

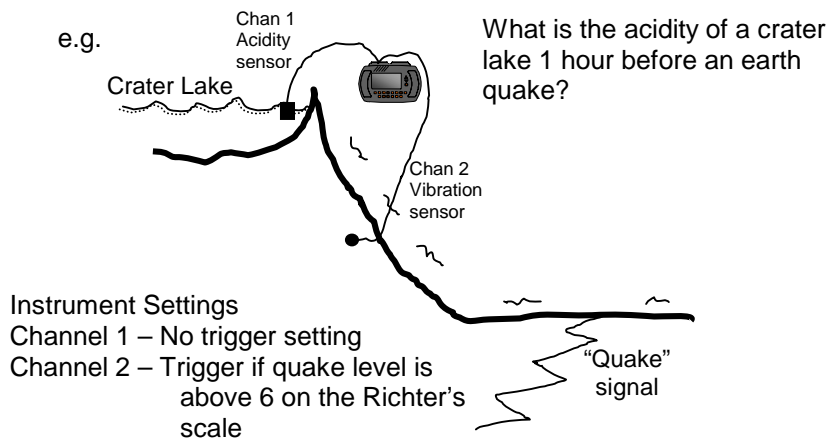

Pre-Trigger set to 1 hour  
 Sample period = 1 second  
 Record for 2 hours

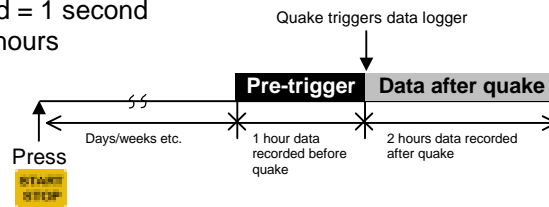

Once Pre-trigger is set, the data logger can be left for days, weeks etc. When the specified trigger level occurs, pre-trigger data is already saved in memory.

- 5 **Post Trigger** - start recording data to memory after a specified time has elapsed once a level trigger has occurred.

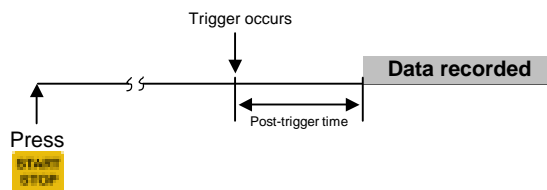

- 6 **Enable Channels** - select the channels you would like to record.

- Note:**
- Faster sampling rates are available if fewer channels are selected.
  - Less memory is used if few channels are enabled.

- 7 **Sampling Period** - the amount of time between samples.

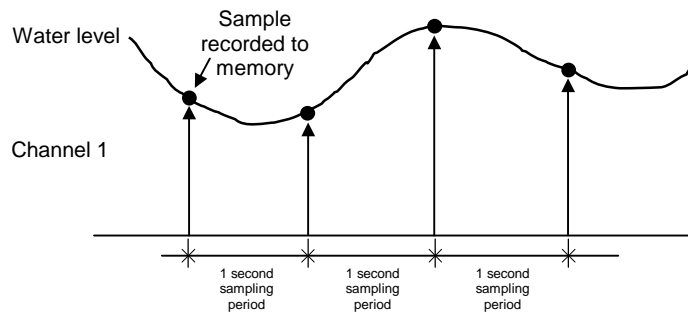







- Note:** There is a fraction of a second delay between channel 1, 2, 3 etc. recordings.

**7** **Record For...** - the amount of time to record for, or the number of samples to take before recording automatically stops.

**Note:** If "*Auto Repeat Recordings*" (under the file menu) is selected and level trigger is also selected, a new file will be created as soon as the recording time has finished. This way you can get a separate file every time a lake level goes into flood for example.

## 2.3.2 Setting Display Options

To specify how measured data is to be displayed:















- Access the main menu (see section 2.1.2).
- To display measured data in the form of text, press *Display* ▶ *Text*. The real-time readings are displayed for each enabled channel.
- To display measured data in a text with minimum and maximum values, press *Display* ▶ *Min/Max*.
- The min and max values are reset whenever a new recording is started, or   is pressed.
- To edit the measurement unit for a channel, press *Display* ▶ *Edit Units...* In the *Enter Channel Unit* window, select the channel by pressing  or  and then edit the name of the unit (see section 2.1.5).
- To edit the name of a channel, press *Display* ▶ *Edit Names...* In the *Enter Channel Name* window, select the channel by pressing  or , and then edit the name of the channel (see section 2.1.5).
- To swap temperature units between degrees Celsius, degrees Fahrenheit and User defined setup, press *Display* ▶ *Temperature Units*:

## 2.3.3 Graph Controls

To view an xy-graph:

- Press *Display* ▶ *Graph*.

The following controls are available when viewing a graph. When a file is being played back, additional cursor and zoom controls are available.

Option	Meaning
	Active cursor moves right (Playback only)*
	Active cursor moves left (Playback only)*
	Toggle active cursor (Playback only)*
	Zoom In and Out between cursors (Playback only)*
KEYS 1 – 9, 0	Select channel 1 to 0
  (quick key press)	Increase y-axis scale
  (quick key press)	Decrease y-axis scale
  (continuous key press)	Scroll graph up
  (continuous key press)	Scroll graph down
 	Resets graph settings to default

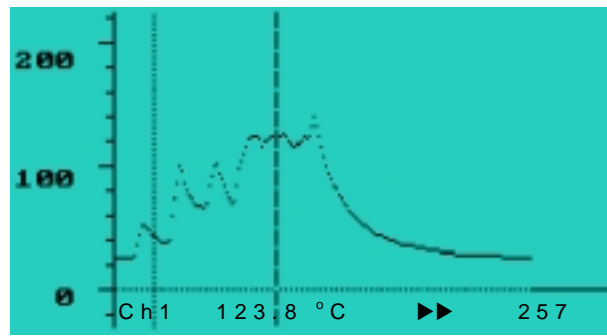

(Playback only)\* - Cursors are available only when playing back a file. For more information on *Playback* mode please see sections 2.5 and 2.6.



↑  
Channel being  
examined

↑  
Value at  
active cursor

↙  
Sample  
number at  
active cursor

**Note:** To leave the “Playback” environment either press   or select *Display* ▶ *Exit Playback*.

## 2.4 RECORDING DATA

### 2.4.1 Setting Up the Filename

The data recorded in a single recording session is stored as a file. The name of the file into which data will be recorded is displayed at the bottom of the data-display screen.

- To edit the name of the file, press *File* ▶ *New Recording*. In the *New Recording Setup* window, select *Filename* and edit the filename in the *New File Name* window (see section 2.1.5).
- File names are automatically numbered after the first recording e.g. Lake level, Lake level 1, Lake level 2... etc.

### 2.4.2 Choosing a Folder

For identification purposes, it is convenient to group files that are related under a common folder.

- To choose the folder under which the recording file is to be grouped, press *File* ▶ *New Recording*. In the *New Recording Setup* window, select *Folder*, and in the *Save Recording in Folder...* window, select the folder.
- If a new folder is required, press *Folder* in the *Save Recording in Folder...* window, select the new folder, and then press *Rename* to edit its name. Then select the newly created folder in order to place the recording file in it.

## 2.4.3 Starting a Recording

- From the main display screen press  to start the recording.

Data will be recorded and displayed according to how the inputs, trigger, and display options were set up. The sample number is updated on the bottom right of the screen as the samples are collected.

The data is recorded into the file and folder you chose earlier (the name of the file is displayed at the bottom of the screen).

## 2.4.4 Auto-Repeating Recordings

If recordings are level-triggered, the instrument can be instructed to take recordings repeatedly. This is useful for capturing the next level trigger event.

To auto-repeat level-triggered recordings:

- Press *File* ▶ *Auto Repeat Recordings* to check (✓) the option.
- To stop a recording press the  key.

## 2.4.5 Chained Recordings

The instrument has a maximum capability of approx 60,000 data points per individual recording. When this size is reached, another file is created and recording continues without intervention or loss of data.

**Note:** Each sample of each channel uses up a data point, e.g. a 4 channel recording of length 10,000 samples uses up 40,000 data points.

Chained recordings are denoted with an 'x'/y' extension. Which can be interpreted as the xth number part of a total of y parts.

e.g.     Untitled 1/2  
          Untitled 2/2

When transferring to MAS, if the entire folder is selected and sent, then the chained recordings will be recombined into a single long recording.

## 2.5 PLAYING BACK

To play back a recording:

- Press *File* ▶ *Examine files...*



- In the *Playback File* window, select the recording to be played back and press **ENTER**.



**Note:** Recordings can be played back in either the text, bar or graph display modes, irrelevant of the mode that they were recorded in.

- In the data-display screen, press **▲** to move forward through the samples and **▼** to move backwards. Press **START** to return to the beginning of the recording (the sample number is displayed at the bottom right of the screen). The instrument beeps when you have reached the first and last samples.
- The display type and units can be altered in the playback, any changes made during playback are only for the duration of the playback. This allows recordings to be viewed in an alternative view from the way that they were recorded.
- To exit Playback mode either press **SHIFT** **ESC** or *Display* ▶ *Exit Playback*.

**Note:** In the *Playback File* window, there are also options to rename or erase a folder or recording, create a new folder and collapse or expand the data tree.

## 2.6 FILE UTILITIES

In the file selection window (*File ▶ Examine Files*) the following utilities are available:

Option	Meaning
1. <i>Shrink / Expand</i>	Shrinks or Expands the File Folder structure to make selecting a folder easier and quicker.
2. <i>Folder</i>	Creates a NEW FOLDER.
3. <i>Rename</i>	Renames a file or a folder.
4. <i>Copy</i>	Copies the selected file's setup (channel names, units, trigger type etc.) so that the next recording's setup is the same.
5. <i>Lock</i>	Prevents a file from being erased with the "ERASE" option. This option can be used to lock your recordings so their setups are protected and can then be copied at a later date. WARNING: <i>File ▶ Erase All Memory</i> will erase a locked file.
6. <i>Erase</i>	Erases the selected file or folder (does not erase locked files/folders).
7. <i>Snd to PC</i>	Sends the selected file or folder to the PC (see section 4).
 or 	Selects a file for playback or selects the active FOLDER to record into (if Window Title is "Save Recordings in Folder...").

## 2.7 OUTPUTTING SAMPLES FROM RS232

Press *File* ▶ *Output Samples to RS232* to send real time data in ASCII format from the instrument's RS232 port.

This data can be captured by a PC (e.g. using HyperTerminal).

Channel Number	Values	
1	4.5000	} Approximately 200ms between channel readings
	6.8251	
	100.02	
	99.800	
	4.6000	} Cycle continuously repeats
	6.8252	
	100.00	
	200.00	

### Format of Data

<channel number><space><channel value><CR><LF>

(8 data bits, no parity bit, 1 stop bit)

The default bit rate is 9600 bits/second, but it is possible to have the instrument send data at 57600 or 19200 bits/second.

To select a higher rate, send the instrument approximately 20 'Q' characters (e.g. press Q in HyperTerminal 20 times) at the bit rate you desire.

- Note:**
- '\*' characters will be echoed while the 'Q' characters are being transmitted.
  - Operating the instrument's menus may temporarily disrupt the transmission of samples from the RS232 port.
  - Transferring files to MAS cancels RS232 sample transmission.
  - When using Timer Trigger, COMs will default to 9600 bits/second after the first wakeup.



# UTILITIES



This section outlines the procedure for performing utility functions on your instrument . You will learn to:

- reset the instrument ;
- adjust the instrument LCD;
- set the instrument clock;
- manage the instrument battery pack;
- manage memory usage on the instrument ; and
- troubleshoot the instrument .

**WARNING:** Read section 1.4 before operating your instrument .

## 3.1 RESETTING THE INSTRUMENT





Sometimes, due to electrostatic discharge exceeding 8kV, the instrument may not respond to any key presses (including  presses). In such cases, it is important to reset the instrument as soon as possible. To reset the instrument :

- Press  while holding down  and then release them both simultaneously, once the initialization screen has been displayed.

Once reset, the instrument displays the *Initialization* screen and resumes normal operation. Resetting the instrument does not erase data or settings stored in the instrument .



## 3.2 ADJUSTING LCD

### 3.2.1 Adjusting Contrast

- Press *Sys* ▶ *LCD-Contrast...*
- To darken the LCD, press . To lighten it, press .
- To restore the default contrast, press  then .

If the screen flickers when cursors are moved, make the LCD darker.

### 3.2.2 Turning Backlight On

To toggle the backlight ON and OFF press  then .





## 3.3 SETTING CLOCK

### 3.3.1 Checking Date and Time

- Press *Sys* ▶ *Clock*.

All recordings are date and time stamped according to the clock shown in the *Date & Time* window.

### 3.3.2 Setting Date and Time

- Press *Sys* ▶ *Clock*.
- To cycle to a particular field, press .
- To edit the value of a field, press  and .
- Press  when you have finished.

If the *am/pm* hour format is chosen, the hour switches back to 1 at the thirteenth hour. If the *24h* format is chosen, the hour continues incrementing until 23 before switching back to 0.

## 3.4 MANAGING BATTERY

### 3.4.1 Instrument Battery

The instrument is powered by a rechargeable Nickel-Cadmium (Ni-Cad) battery pack. The normal operating voltage is 6.0 to 8.5 Volts.

Some automatic features have been built into the instrument to help ensure that the battery pack is always sufficiently charged. Below 6.6 Volts, the instrument displays a flashing  icon at the bottom right corner of the screen and beeps once every minute as a reminder that the battery pack needs to be charged. Below 6.1 Volts, the instrument automatically turns off the backlight to prevent further power draining. Below 80% battery capacity, the instrument automatically begins to charge the battery pack (if external power is supplied). At 5.5 Volts, the instrument automatically powers down. The power saver is another feature that helps conserve power on the instrument – see section 3.4.6.

There is also an internal backup battery that backs up data and settings in the instrument in the event that the battery pack is detached from the instrument. The backup battery is kept charged by the battery pack if the battery pack is functioning normally.

**WARNING:** Do not detach the battery pack from the instrument for more than 2 hours as this will drain the backup battery, thereby causing data and settings to be lost.

The battery pack can be charged by supplying  $13.5 \pm 1.5\text{VDC}$ , 1A power to the instrument charger socket. The power transformer supplied in the kit provides this DC voltage. The optional car adapter charging lead may also be used to charge the battery pack in a vehicle with a 12-Volt negative-chassis power system.

**WARNING:** Before charging the battery pack, ensure that the power transformer used is an approved instrument power transformer ( $13.5 \pm 1.5\text{VDC}$ , 1A output) and that the voltage and frequency of your mains AC power match that of the power transformer.

## 3.4.2 Checking Battery Capacity

- Press *Sys*

The remaining battery capacity and voltage are displayed.

## 3.4.3 Charging Powered-up instrument

**WARNING:** See the warnings in section 3.4.1.

- Plug the instrument power transformer into a standard power outlet and its connector to the instrument charger socket. If the battery capacity is less than 80%, charging begins automatically.
- If charging does not begin automatically, press *Sys* ▶ *Charge Batt* Charging, as indicated by the  icon in the dropdown menu, begins.

If the  icon is not displayed, check that the mains power is turned on. Charging stops automatically when complete or you can press *Sys* ▶ *Charge Batt* to stop it. A full charging cycle takes approximately 150 minutes. All other functions are usable while the battery pack is being charged.

## 3.4.4 Charging Powered-down instrument

**WARNING:** See the warnings in section 3.4.1.

- Plug the instrument power transformer into a standard power outlet and its connector to the instrument charger socket. The instrument powers up and charging, as indicated by the flashing “CHARGING” message beside the *Charge Batt* option in the *Sys* dropdown menu.

If the instrument does not power up, reset the instrument (see section 3.1), or unplug the power transformer connector and re-plug it in. See also section 3.4.3 notes.

### 3.4.5 Reconditioning Battery Pack

**WARNING:** See the warnings in section 3.4.1.

Battery reconditioning is the process of first discharging and then charging batteries. It reduces the undesirable memory effect in Ni-Cad batteries. The battery pack should be reconditioned when it is first used (for its capacity to be displayed correctly) and monthly thereafter (to prevent battery degradation). To recondition the battery pack:

- Plug the instrument power transformer into a standard power outlet and its connector to the instrument charger socket.
- Press *Sys* ▶ *Recondition Batt.*

After discharging the battery pack, the instrument automatically proceeds to charge it. See also section 3.4.3 notes.

### 3.4.6 Power Saver

Every time the instrument is powered up, the power saver – a power-saving feature – is automatically turned on. With the power saver turned on, the following occurs automatically if no keys are pressed for a period of time: after 8 minutes, the LCD is turned off (but any key press will turn it on again) and after 15 minutes, the instrument is powered down. To turn the power saver on or off:

- Press *Sys* ▶ *Power Saver.*

### 3.4.7 Replacing Battery Pack

- Lift the boot stand.
- Unscrew the battery pack and screw in the new one using a suitable screwdriver or coin.

**WARNING:** Ensure that the battery pack is securely fastened – but not over-tightened – to the instrument .

## 3.5 ERASING MEMORY

**WARNING:** Following the procedure below erases **ALL** folders and **ALL** recordings in the instrument .

Before erasing data, you may wish to archive it on your PC (see section 4.3). To erase all folders and recordings:

- Press *File* ▶ *Erase ALL Memory...*
- In the *Erase All !* window, press  and  together and wait for the data to be erased.

To erase only one particular recording or folder, see section 2.5.

**WARNING:** Erase All Memory will reset the instrument to factory default settings. All locked folders and files will be erased.

## 3.6 TROUBLESHOOTING

### 3.6.1 Power Problems

Symptom	Cause	Remedy
Instrument cannot power up	Low battery capacity Electrostatic discharge (ESD) exceeding 8kV	Charge battery pack Reset instrument
Instrument powers down when backlight turned on	Low battery capacity	Charge battery pack
Instrument powers down shortly after powering up	Low battery capacity	Charge battery pack
Flashing  icon and beeping every minute	Low battery capacity	Charge battery pack

### 3.6.2 Data Problems

Symptom	Cause	Remedy
Data lost when battery pack detached for more than 2 hours	Flat backup battery	Charge battery pack
Data lost when battery pack detached for less than 2 hours	Faulty backup battery	Send instrument to authorized dealer for servicing
“Insufficient memory” displayed	No memory space left for recordings	Erase obsolete recordings (transfer to PC first if necessary)
Measured data seems incorrect	Sensor wired wrongly	Wire as recommended
	Faulty sensor	Replace sensor

### 3.6.3 Data-Transfer Problems

Symptom	Cause	Remedy
"No PC ?" displayed, and data cannot be transferred to PC	Data-transfer cable not properly connected	Re-secure cable connections
	Data-transfer cable connected to wrong PC COM port	Test COM port availability and use available port
	Baud rate setting in MAS-3000 too high	Select a lower baud rate in MAS-3000
MAS-3000 unable to transfer data and "Transfer failed" or "MAS Error Dialog" displayed on PC	Baud rate setting in MAS-3000 too high	Select a lower baud rate in MAS-3000

### 3.6.4 Other Problems

Symptom	Cause	Remedy
Instrument does not respond to any key press	Electrostatic discharge exceeding 8kV	Reset instrument
"Module fault" displayed	Module <sup>‡</sup> damaged	Send instrument to authorized dealer for servicing
"Switch off then connect module" displayed	Module not properly plugged into instrument	Power down instrument then re-secure module, making sure not to bend the connection pins

---

<sup>‡</sup> The "module" is the measurement hardware unit of the instrument. It has the six temperature measurement channels and 4 voltage measurement channels attached to it and is fastened to the rest of the instrument by means of two M3x0.5x12mm screws.



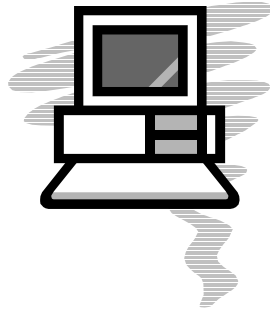

# ANALYSIS SOFTWARE

Recordings made on your instrument can be transferred to the MAS software running on a Windows® based PC. MAS stands for **M**asurement **A**nalysis **S**oftware. MAS can be used to store, graph, analyse, print & export your recordings.

It is assumed that the user of MAS is already familiar with basic Windows® commands. Please refer to the appropriate literature on Windows® if clarification is needed on mouse and keyboard commands.

**Note** Throughout MAS, pressing F1 on your keyboard will bring up a comprehensive topic-specific Help screen. Also, clicking the right mouse button anywhere in MAS will bring up a pop-up menu of the applicable commands.

**WARNING:** Read section 1.4 before operating your instrument .

# 4.1 INSTALLING MAS-3000

## 4.1.1 License Agreement

Please read the license and warranty agreement printed on the CD cover found in the jewel case that the MAS CD-Rom was supplied in. MAS is licensed for individual use and for installation on one computer. The software contained on the CD-Rom remains the intellectual property of COMMTEST INSTRUMENTS who retain the title and ownership of the software.

## 4.1.2 PC System Requirements

The following are the minimum system requirements for installing MAS:

- Pentium or better
- 32MB RAM (64MB recommended)
- 10MB hard disk space
- CD-Rom drive
- Windows® 95, 98, Me, NT or 2000 operating system
- Windows® compatible display and printer
- Windows® compatible mouse or other pointing device
- An unused COM Port for communication with the instrument

### **4.1.3 Installing MAS on PC**

- Close all programs on your PC.
- Insert the MAS CD-Rom into the CD-Rom drive.
- Wait for the MAS Installation program to automatically start (or run Setup.exe located on the CD-Rom).  
OR  
Run the MAS Setup.exe program located on the CD-Rom.
- Follow the instructions given to complete the installation.

## 4.2 STARTING UP MAS

### 4.2.1 Starting up

- Click *Start* ▶ *Programs* ▶ *MAS-3000* ▶ *MAS-3000 5.00*

### 4.2.2 Configuring PC COM port

- To allow data transfer between the instrument and the PC, you must first configure your PC COM port as follows:
- Connect the instrument to one of the COM ports using the data-transfer cable and power up the instrument .
- Click *Tools* menu ▶ *Configure COM port*.
- Select the COM port that the instrument is connected to.
- Select a baud rate. The baud rate is the speed (in bits/second) at which data is transferred. The lower the baud rate, the less likely are data-transfer errors. *Automatic* is the default choice as it is sufficient for normal transfers.
- Click *Test port*
- Click *Yes* in the *Confirm* window to test the connection. Connection failure may be due to the selection of the wrong COM port in MAS, the instrument being not powered up, connectors being not plugged in properly, or the PC serial port being not set up properly. If the connection is good, continue as follows:
- Click *OK* in the second confirm window to acknowledge that the instrument is attached to the COM port.
- Click *OK* to leave the *MAS Configuration* window.

## 4.3 TRANSFERRING DATA TO THE PC

Data transferred to the PC is stored in MAS *files*. These are text files and have the .mas extension.

To transfer data from the instrument to the PC:

- Turn on the instrument Check its battery capacity and if less than 30%, charge the battery pack.
- Connect the RS232 port of the instrument to the configured PC COM port using the data-transfer cable. On the PC click the *Receive* button.
- On the instrument , press *File* menu ▶ *Examine Files...* Use the arrow keys to select the individual recording or folder to be transferred. If a folder is highlighted, all recordings within the folder will be transferred.
- Press  *SndToPC* to send the selected recording or folder. Once the data-transfer is complete, the data will appear in the current file in MAS or if no files were open, the data will appear in a new file.
- To append more data from the instrument to the current file, click the *Receive* button.
- Alternatively, to receive more data but in its own new file, click *File menu* ▶ *Receive from MMS* ▶ *Transfer to a New File*.
- To save the data in the current file, click the *Save* button, name the file and click *Save*. If the file was an already existing file, clicking the *Save* button will automatically save the file under the same name and in the same location on the PC.

## 4.4 MANAGING DATA

### 4.4.1 Opening a File

- Click *Open* button and select the file.

### 4.4.2 Merging Two Files

- Open one of the files.
- Click *File* menu ▶ *Import & Merge a file...* and select the other file to be merged into the open file.

The merged data can be viewed but is not automatically saved on the computer. To save it, click *File* menu ▶ *Save* or *Save As*.

### 4.4.3 Using the Navigator

When a file is open, the navigator that consists of two boxes is displayed on the left side of the screen. The top box shows all the folders in the file. The bottom box shows all the recordings in the selected (highlighted) folder in the top box.

### 4.4.4 Deleting Data from a Folder

- Select the folder in the *Folder* section of the navigator.
- Using the navigator, select the individual recordings and/or channels to be deleted.
- Click *File* ▶ *Delete*, or press the *Delete* key. You will then be prompted to confirm that you wish to delete the selected recordings/channels

## 4.4.5 Editing Recording Details

- Select the folder, and then the recordings and/or channels to be edited.
- Click the *Info* tab to access the *Info page* where you can edit the *User Details* (eg. Company Name, instrument serial number...), *Folder Name*, and the *Recording Details* (eg. recording name, remarks, channel labels and units...).
- From the *Edit User Details* screen there is access to edit the *Default User Details*. These values are written to all future recordings, while they are transferred from the instrument .

## 4.4.6 Viewing and Printing Data

- Open the file and using the navigator, select the recordings and/or channels to be viewed and/or printed.
- Click the *Values* tab. The data in the selected recordings and/or channels can now be viewed.
- To change the value in a cell, click the cell and type in the new value.
- To reduce the amount of data by averaging, click the *Average* button.
- To print the data, click the *Print* button.
- To copy the values to a spreadsheet program, click the *Copy* (to clipboard) button, go to the Spreadsheet program and use its' *"Paste"* command.
- To print a report on the data, click *File* ▶ *Summary Report*<sup>§</sup> or *Full Report*\*\* and select the print option in the *Data Summary* or *Report Generator* window that appears.

---

§ The Summary report produces a data summary about the selected recordings/channels. For more information consult the MAS help file.

## 4.4.7 Exporting data

- In the Navigator select the folders or recordings to be exported as a .mas file.
- Click *File* ▶ *Export* and select the option required.
- Provide the name and location of the export file to be produced and then click the *Save* button.

---

\*\* The Full report produces an exact printout of the pages selected in the report generator window. For more information consult the MAS help file.

## 4.5 CALCULATING DATA

You can perform calculations on your recorded data by creating new "calculated" channels:

- Open the file and using the navigator, select the recordings and/or channels to be used in calculations.
- Click the *Values* tab to display the data and click the *Calculate* button to access the *Calculate* window.
- Each channel is automatically given a "**tag**" character that is used to identify the channel. It is a letter of the alphabet that can be used to reference the values of a recording for use in calculations.
- Expressions can then be derived using the provided functions and the channel tags<sup>††</sup>.

eg.  $\text{TempChange} = \text{ChangePerHr}(B)$  with units degC/hr

This example will create a channel called "*TempChange*" which is calculated as the rate of change per hour of the channel which has tag '*B*'.

- Constants can also be used in calculations. You may need to use constants in your expressions, for example:

To find the "difference from the mean value" for a particular channel, say the channel represented by "**tag**" '*D*'.

A constant should be defined to provide the mean value of channel '*D*', " $K0 = \text{Mean}(D)$ "

This constant is then used in the expression,  
" $\text{DiffFromMean} = D - K0$ "

---

<sup>††</sup> See Appendix MAS-3000 MATH for a complete list of functions available.

## 4.6 PLOTTING DATA

### 4.6.1 Plotting Single and Individual Charts

- Open the file and using the navigator, select the recordings and/or channels to be plotted.
- Select the *Chart* tab and click the *Plot* button. You can also plot a recording or channel by double-clicking it in the navigator.
- To display the selected recordings and/or channels on individual charts, click the *Individual* button.
- To change the format of charts, click the *Adjust* button to access the *Adjust Axes & Colors* window. This window allows for changes to be made to the axes and colors of the plotted recordings displayed on the chart.
- To clear all plotted recordings, click *Chart* menu ▶ *Clear Chart*. To retain existing plots when adding to the chart, click the *Hold* button. A maximum of 16 plots can be displayed at a time

To enlarge a chart, you can hide the legend by clicking *Chart* menu ▶ *Show Legend*. You can also Hide the navigator by clicking *Window* menu ▶ *Show Navigator*.

## 4.6.2 Zooming & Panning

### To zoom in on any part of a chart:

- Click a point to the left of that part of the chart and drag a rectangle across and down to the right over the section to be enlarged (while holding down the left mouse button). Release the mouse button to perform the zoom.

### To zoom in horizontally:

- Proceed as above, but only move the mouse directly up or down to select the area to be enlarged. Two horizontal lines will be displayed across the chart to indicate the selection.

### To zoom in vertically:

- Proceed as above, but only move the mouse directly left or right to select the area to be enlarged. Two vertical lines will be displayed across the chart to indicate the selection.

### To unzoom from any view:

- Left click on any point in the chart and drag a rectangle up and to the left to display a rectangle with a cross in it. When the mouse button is released all zooming will be undone and the chart will be returned to its original view.

### Panning

- The chart displayed can be dragged in any direction to display sections that are hidden from the current view. To pan around the chart click and hold down the right mouse button in the chart display. The cursor will turn into a pointing hand icon. Drag the mouse pointer in the direction that you wish to move the chart.

**Note:** If you move the cursor off the chart, you will have to release the right mouse button and return it to within the chart boundaries to continue panning.

## 4.6.3 Printing Charts

- Click *Print* while the chart is displayed.

## 4.6.4 Reading and Comparing Values

To place cursors on charts to read the data values on curves:

- Plot the recordings and/or channels on a single chart.
- To place a cursor at a particular point on a curve, place the mouse cursor at that point, follow the curve until a crosshair appears, and then click the left mouse button. If the default cursor options are used, the cursor comprises a horizontal and a vertical dashed line, and the values indicated by the cursor are displayed at the edge of the chart next to the dashed lines.
- To move the cursor to a different point on the same curve, press the horizontal arrow keys. To move in small steps, hold down the Ctrl key when pressing the horizontal arrow keys. You can also move the cursor by clicking the left mouse button on the new point (first allowing a crosshair to appear).
- To move the cursor to a different curve, push the vertical arrow keys. Alternatively, click the left mouse button on the new curve, or on the appropriate symbol on the legend.
- To place a second cursor on the chart, place the mouse cursor at the point of interest, follow the curve until a crosshair appears, and then click the right mouse button. If the default cursor options are used, the difference between the values indicated by the cursors is shown at the top right corner of the chart. Cursor A corresponds to left mouse button and cursor B to the right.
- To toggle the focus between the cursors, push the space bar, a cursor must be focused before it can be moved using the arrow keys. A cursor is focused if it has a rectangular target.
- To clear the cursors, push the Esc key.
- To change cursor options, click *Chart* menu ▶ *Cursor Options....*

**EXAMPLE:** a two-channelled temperature recording with both cursors displayed (using the default cursor options).

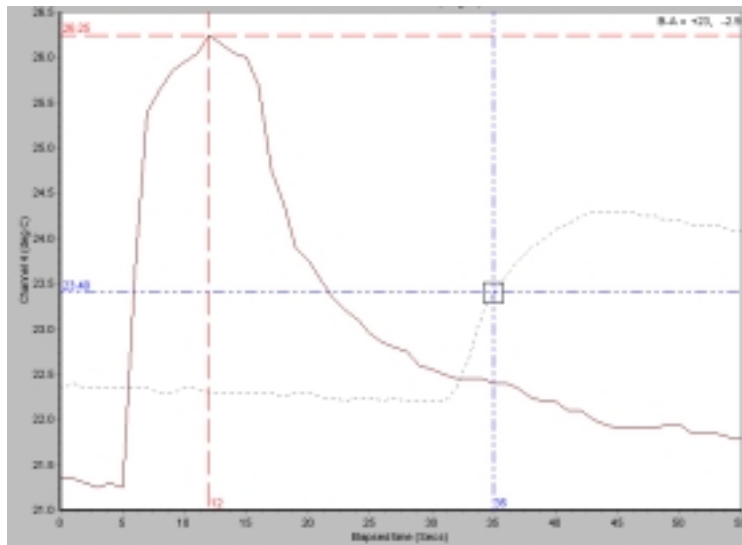

Each cursor displays the x and y axis values and the difference in both the x and y axis values of the two cursors in the top right hand side of the chart.

## 4.6.5 Plotting Waterfall Charts

- Plot the recordings and/or channels on a single chart.
- Click *Chart* menu ▶ *Waterfall Chart* and select the depth required.

Waterfall charts are useful for trending data behaviour. As on ordinary charts, cursor and zooming functions can be used on waterfall charts.

**EXAMPLE:** the four curves on the waterfall chart below correspond to three sets of data pertaining to the same measurement point. It can be seen that the peak value has a rising trend.

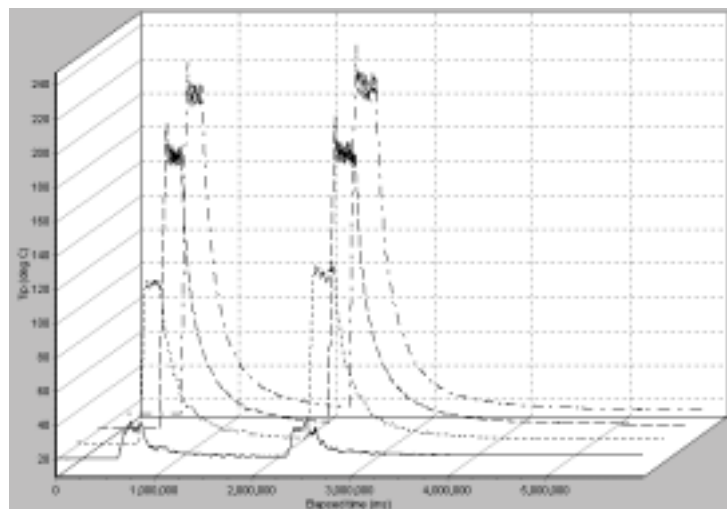

## 4.7 UPGRADING FIRMWARE

When an upgraded instrument firmware version is available, it will be posted on the COMMTTEST INSTRUMENTS website. Once you have obtained the firmware file, the firmware can be upgraded using the PROFLASH procedure below.

**WARNING:** Upgrading the firmware erases all data in the instrument.

- Check the instrument battery capacity and if it is less than 30% charge the battery pack.
- Connect the RS232 port of the instrument to the configured PC COM port using the data-transfer cable.
- Power up the instrument and transfer any data you wish to keep to MAS on a PC.
- In MAS click *Tools* menu ▶ *PROFLASH MMS*. In the *PROFLASH* window click the *PROFLASH* button ▶ *Automatic search*.

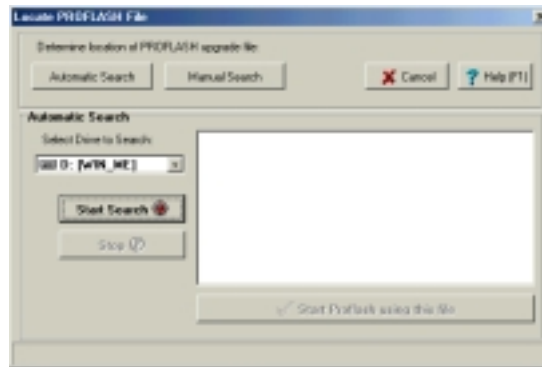

- Click *Select Drive to Search* and select the drive where the new firmware version is located.

- Click *Start Search*, and when the search is completed select the new firmware file.
- Click *Start proflash using this file*.

Once the proflashing is complete, the instrument will beep and the Initialisation screen will appear. If an error occurs, check that the data-transfer cable has been connected properly and that the instrument is powered up.

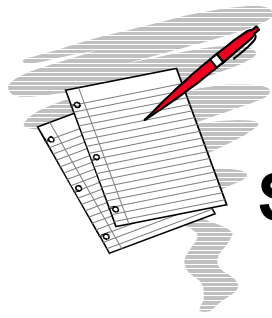

# Appendix SPECIFICATIONS

The following are the specifications for:

- instrument firmware version 2.10
- MAS software version 5.00

These specifications may be changed in future versions.

Specifications	Model: MMS3000-T6V4 6 Temperature Channels Incorporating 4 Voltage Channels			Remarks
<b>Range</b> T Type Thermocouple E Type Thermocouple J Type Thermocouple K Type Thermocouple Voltage Common Mode Range	-418 to +743°F (-250 to +395°C) -418 to +1823°F (-250 to +995°C) -346 to +2183°F (-210 to +1195°C) -418 to +2498°F (-250 to +1370°C) ±5VDC and ±30VDC (user-selectable) ±30VDC (voltage channels only)			Operating temperature range is determined by operating range of thermocouple.  Differential inputs. Voltage allowed between channels and input ground.
<b>Resolution</b> Temperature Voltage	Above -148°F (-100°C): 0.1°F or °C At or below -148°F (-100°C): 1°F or °C ±5VDC: 200µV (0.0002V) ±30VDC: 1mV (0.001V)			Effective resolution decreases at or below -148°F (-100°C).
<b>Accuracy</b> Temperature Voltage Common Mode Error	Above -148°F (-100°C): ±0.1% of reading ±0.9°F (0.5°C) At or below -148°F (-100°C): ±1% of reading ±0.9°F (0.5°C) ±5VDC: ±0.3% of reading ±0.6mV ±30VDC: ±0.3% of reading ±3mV 0.1% of common mode voltage			Temperature measurement accuracy depends on MMS3000-T6V4 and thermocouple accuracy. Only MMS3000-T6V4 accuracy is given here. MMS3000-T6V4 temperature 73 ± 9°F (23 ± 5°C), charger off. See Appendix Optimizing Temperature Accuracy.
<b>Minimum Sampling Interval</b>	Number of channels selected (user-selectable)	Voltage channels selected (seconds)	Temperature or voltage channels selected (seconds)	Minimum time to scan all selected channels - not each channel.  Sampling interval is programmable from 0.2 seconds to 60 hours.
	1	0.2	0.2	
	2	0.3	0.3	
	3	0.4	0.5	
	4	0.5	0.6	
	5		0.7	
	6		0.8	
	7		0.9	
	8		1.0	
<b>Data Logging</b> Data Storage Format  Data Storage  Folder Name	Up to 50 named folders Multiple recordings per folder Recording length: 1 sample ... entire memory  512 kilobytes – approximately 400,000 individual data points  Up to 16 alphanumeric characters			User-specified name entered from keypad. Each recording has unique time/date stamp. Supports long recordings by chaining 60,000 data point recordings. Each sample contains one data point per channel.  Non-volatile memory (battery backup). Number of samples depends on the number of recordings and the variability of the readings.
<b>Display</b> Resolution Viewing Area Backlight	LCD with graphic capabilities 240 x 128 pixels 4.3" x 2.3" (110mm x 60mm) Electro-luminescent			
<b>PROFLASH</b>	Allows internal firmware to be upgraded via built-in serial port			Download firmware updates from the Commtest website.
<b>Communications</b> Baud Rate	RS232 9600, 19200, 57600 bits per second			15kV ESD protected. Cable with DB9 connector included. Automatic baud rate selection.
<b>Channel Organization</b>	Any combination of up to 8 channels for any recording			Channels 5 & 9 and 6 & 0 are shared.
<b>Termination</b> Temperature Voltage	Sockets accept miniature thermocouple twin blade plug Screw terminals			Blades spaced 5/16" (7.9mm) center-to-center.
<b>Input Impedance</b> Temperature Voltage	Channels 1, 2, 3, & 4: greater than 100kΩ Channels 5 & 6: 30kΩ Channels 7, 8, 9, & 0: 2MΩ			Terminal-to-terminal. Terminal-to-terminal (channels 5 & 9 and 6 & 0 are shared). 1MΩ per terminal to input ground.
<b>Isolation</b>	50VDC minimum			Between inputs and MMS3000-T6V4 outputs e.g. RS232 port. No isolation between channels.
<b>Battery</b> Type Voltage Capacity Operating Time	Custom Nickel-Cadmium pack 7.2V nominal 1500mAh nominal 13 hours nominal with backlight off, 7 hours nominal with backlight on			
<b>Charger &amp; Conditioner</b> Fast Charge Rate Discharge Rate	Built-in dual rate charger – automatic and manual control 0.7A nominal 0.5A nominal			Power transformer (13.5 ± 1.5VDC, 1A output) included in kit. 2.5 hours for complete charge nominal. Combats Ni-Cad battery memory effect.
<b>Mechanical</b> Size Weight	9.7" W x 6.1" L x 3.0" H (247mm x 154mm x 75mm) 4.4lb (2kg)			Including protective boot. Including protective boot and strap.
<b>Environmental</b> Temperature/Humidity Operating  Storage EMC	32°F to 122°F (0°C to 50°C) / 80% RH 32°F to 86°F 70% RH 32°F to 122°F  14°F to 140°F (-10°C to 60°C) / 95% RH EN50081-1 EN50082-1			Non-condensing. Non-condensing.  Radiated and conducted emissions. RF field, ESD and fast transient immunity.

© 2000 COMMTEST INSTRUMENTS Ltd.

The manufacturer reserves the right to modify specifications (Rev. 1.86)

# Appendix

## Application Notes

### 6.1 Application Note 1

#### Using the T6V4 Module's Common Mode Inputs

##### Description

The internal circuitry of the T6V4 module measures low-level signals from one of eight differential input channels (8 channel multiplexed differential input A/D converter).

- Four of these multiplexed inputs are dedicated to measuring thermocouple voltages (CH1 to CH4).
- Two multiplexed inputs are dedicated to measuring voltages up to 30VDC through resistive dividers (CH7, CH8).
- The remaining two multiplexed inputs share resistive dividers (CH9 and CH0) with an additional two thermocouple channels (CH5 and CH6 respectively). These inputs can be used for either (but not both) voltage or temperature measurement, depending on the channel number selected.

All channels (and the module ground) are isolated from instrument internal circuitry and the serial cable, battery etc. If only one channel is connected, then there is no need to consider the effects of common mode voltage or AC noise.

However, the channels are not isolated from each other. Each channel has differential inputs (i.e. they measure the voltage between +ve to -ve), which allows non-isolated voltage sources to be measured provided:

- common mode voltage restrictions are observed;
- the effect of common mode voltage on accuracy is understood; and
- channel-to-channel leakage current through the T6V4 module is allowed.

### **Restrictions**

**For safety:** Do not apply voltages greater than SELV (see Section 5) (with respect to ground potential) to any input pin. This includes thermocouples that are not isolated but measuring the temperature of a metallic object at high voltage.

**WARNING:**      **The isolation within the T6V4 module is not intended to protect the user from hazardous voltages.**

**To avoid damage:** Do not apply more than 10V between any of the 12 thermocouple input pins, or greater than 5V between any thermocouple input pin and module ground. (This will damage the protection diodes in the multiplexer – see the “T6V4 Module Equivalent Input Circuit” diagram below). Example: To measure the temperatures of both terminals of a 12V battery it is essential to use isolated thermocouples.

**To avoid incorrect readings:** Do not allow any voltage on any multiplexer input to exceed + or - 5V with respect to the module ground. (This ground will float to some intermediate value depending on the voltages present on voltage and thermocouple input pins.) If any one input pin goes out of this range, all inputs may read incorrectly. Example: Measuring voltage from a 12V battery on CH7 while measuring temperature on CH1 from a non-isolated thermocouple at a potential greater than the battery positive – current will flow in through the thermocouple wire, through the input of the multiplexer, and out through the resistive divider of channel 7. This may cause either or both of the readings to be completely incorrect.

**To minimize common mode errors:** Ensure the voltage difference between channels is as small as possible, or at least smaller than the voltages being measured. The best way to do this is to isolate the input sources, in that way the instrument input circuitry itself holds all input sources to the same voltage. Sometimes this is not possible, for example when measuring motor current with a shunt and motor voltage, or measuring the temperature of both sides of a power diode (less than 1V across it) by directly soldering on thermocouples. In these cases, common mode errors need to be kept in mind or checked (see examples 1 and 3).

**To avoid problems with common mode noise:** (See Application Note 2)  
 When isolating signal sources, ensure that the impedance of this isolation is significantly higher than the instrument's input impedance (for AC signals too). If this is not so, common mode voltages applied may be larger than when they were not isolated. Example: long cable and thermocouple runs, when isolated, may act as aerials and pick up large AC voltages (say 50VAC) which would overload the input of the multiplexer, resulting in erroneous readings or even damage.

**T6V4 Module Equivalent Input Circuit**

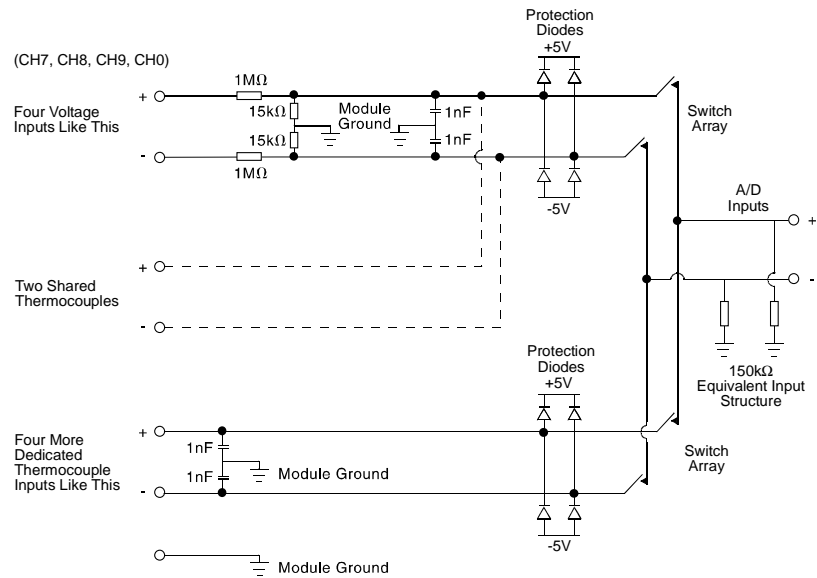

## Examples on Application Note 1

Differential measurements can be confusing to understand. The best way of explaining is with examples.

**Example 1:** Measuring supply current and supply voltage to a DC motor.

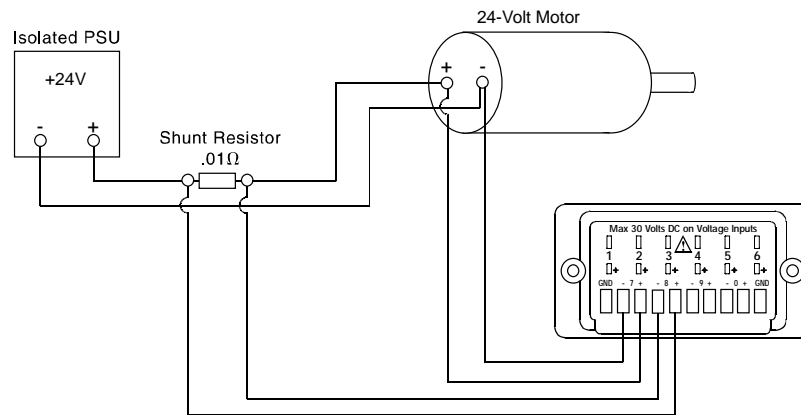

**Example 2:** Measuring signals in a multi-channel 4-20mA system.

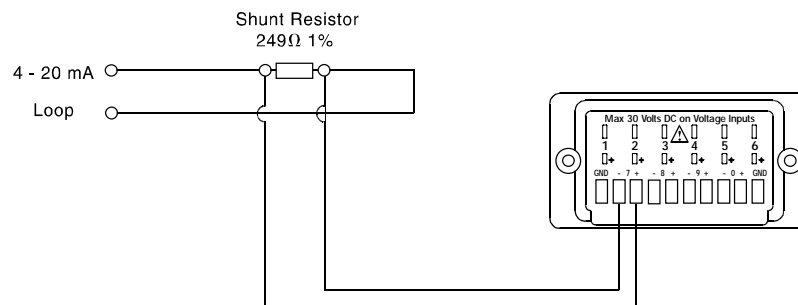

**Example 3:** Measuring case temperature of both sides of a forward conducting power diode while it is operating at SELV (safety extra low voltage).

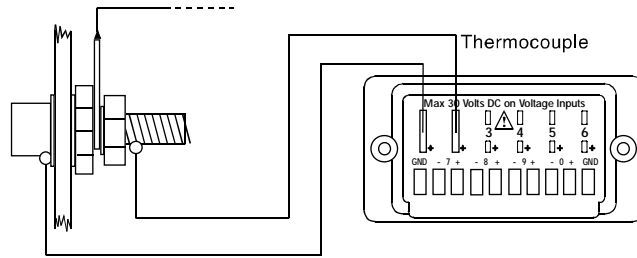

## 6.2 Application Note 2

### Instrument Grounding

In an industrial environment it is common to have AC and/or DC voltages between conductive surfaces that are not bonded together. Conductors that are assumed to be isolated may in fact have a DC leakage, a 50Hz/60Hz AC voltage from inductive or capacitive coupling, or a continual presence or bursts of r.f. voltage (emc).

When using the MMS3000 to measure DC voltages that are not referenced to ground (ie. one point bonded to ground by a low impedance), then connecting a thermocouple to another conductive surface can cause the voltage readings to alter (i.e. become incorrect). It is necessary to check for errors, by observing the voltages while connecting the thermocouple.

In such an environment it is recommended that the metal surface to which the thermocouple is connected, is grounded or wired to the GND terminal of the T6V4 module, as shown in examples 1 or 2.

- Note:**
1. Because the GND terminal on the T6V4 module is the center of the allowable differential voltage range, if the ground of a grounded PSU is connected to the GND terminal, the PSU voltage may not exceed 30V (e.g. do not connect a grounded 48V supply to the instrument as in example 3).
  2. Uninsulated thermocouples cannot be used for measuring temperatures of conductive surfaces that are of different voltages.

## Examples on Application Note 2

**Example 1:** Connecting an isolated PSU to the instrument with thermocouples on a grounded or isolated conductive surface.

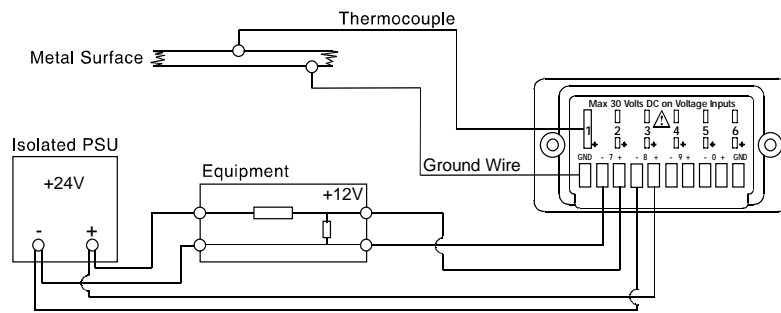

**Example 2:** Connecting a grounded PSU to the instrument with thermocouples on a conductive surface.

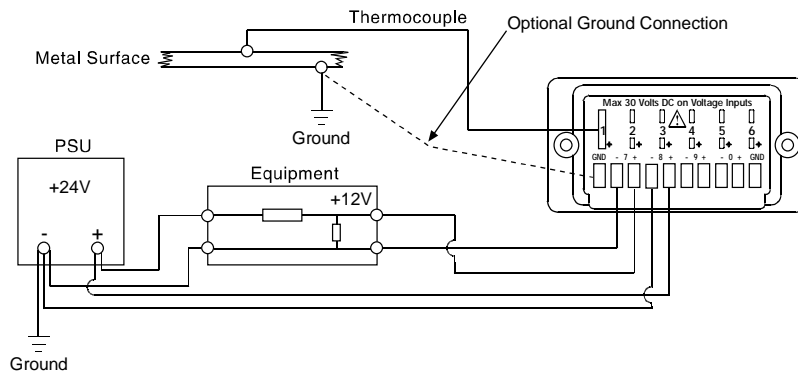

**Example 3:** Grounding to the instrument GND terminal with a PSU with -ve to ground.

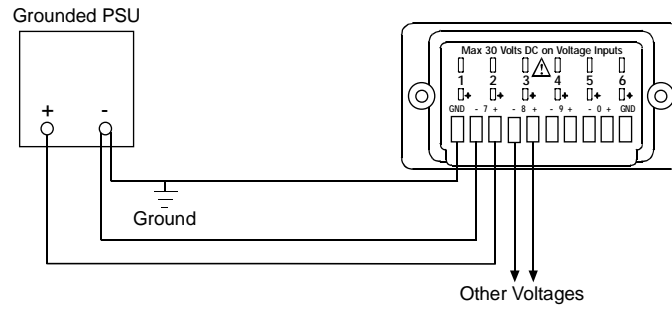

The PSU voltage is limited to +30V, and any other non-isolated voltages measured are limited to within the range of -30V to +30V relative to ground.

# Appendix

## Optimizing Temperature Accuracy

For optimum accuracy when measuring temperature, the instrument internal temperature needs to be stabilized.

This is best achieved by connecting the thermocouple, turning the instrument on and then leaving it on for 30 minutes<sup>‡‡</sup>.

Begin your actual measurement or recording immediately after the 30-minute stabilization period.

For optimum accuracy, the battery charger should not be operated while measuring temperature.

---

‡‡ The “power saver” must first be turned off – see Section 3.4.6 for more details.





# Appendix

## MAS-3000 MATH

The following are the mathematical functions and operators that can be used in MAS-3000 calculations.

The symbols A,B,C,... represent channel tags; and L1, L2, ..., Ln represent logical expressions (e.g.  $\text{int}(A) > 3$ ).

The notation used for functions and operators is similar to that used in common computer-programming languages and spreadsheet programs.

# 8.1 FUNCTIONS

## 8.1.1 Mathematical Functions

Function	Meaning
Abs(A)	Absolute value
Cos(A)	Cosine
Deg(A)	Convert from radians to degrees
DegC_to_DegF(A)	Converts Celsius to Fahrenheit
DegF_to_DegC(A)	Converts Fahrenheit to Celsius
Exp1	Base of natural logarithm, e (constant)
Exp(A)	Exponent
Frac(A)	Fractional part
Int(A)	Integer part
Ln(A)	Natural logarithm
Log(A)	Base 10 logarithm
Max(A, B, ... )	Return the maximum value
Min(A, B, ... )	Return the minimum value
N	Sample number (starting from zero)
Pi	$\pi$ (constant)
Power( <i>base</i> , <i>power</i> )	<i>base</i> to the power of <i>power</i> e.g. Pow(A,3) gives $A^3$ Pow(3,k1) Pow(A,B)
Rad(A)	Convert from degrees to radians
Round(A)	Rounded value
Sgn(A)	Sign (-1 if negative; +1 if positive; 0 if zero)
Sin(A)	Sine

Function	Meaning
Sqr(A)	Square
Sqrt(A)	Square root
Tan(A)	Tangent
ChangePerDay(A)	Rate of change (differentiation)
ChangePerHrs(A)	e.g. If channel 'A' changes smoothly from 10 to 25 over a 1 minute period, then ChangePerMin(A) will be 15 over that period.
ChangePerMin	
ChangePerSec	
SumOverDays	
SumOverHrs	e.g. If channel 'A' is a 2hr recording with all values = 3.5, then SumOverHrs(A) changes smoothly from 0 to 7 over the recording.
SumOverMins	
SumOverSecs	

## 8.1.2 Iterative Functions

The following iterative functions can be used for constants only. Cell level expressions cannot contain iterative functions.

Function	Meaning
Count(A)	Number of samples
Maxsample(A)	Maximum sample value
Mean(A)	Mean
Minsample(A)	Minimum sample value
Stddev(A)	Standard deviation
Sum(A)	Sum

## 8.1.3 Logical Functions

Function	Meaning
AND(L1, L2, ..., Ln)	Logical AND e.g. AND(n = 10, k2 > 0.5, k3 > 0.5, k2 <> k3)
False	Logical constant, has value 0
OR(L1, L2, ..., Ln)	Logical OR e.g. OR(k0 = True, k1 < 3, n >= 30)
True	Logical constant, has value 1
AOR(L1, L2, ..., Ln)	Logical AOR (exclusive OR) e.g. AOR(k0 = True, k1 < 3, n >= 30)
NOT(L1, L2, ..., Ln)	Logical NOT e.g. NOT(k1 =True, k2< 10, n>30)

## 8.1.4 Conditional Functions

Function	Meaning
IF(L1, <i>true result</i> , <i>false result</i> )	<p>If logical expression L1 is true, execute <i>true result</i>, otherwise execute <i>false result</i> e.g.</p> <p>IF(k2 &gt; k3, k2*A, k3*A)</p> <p>IF(k0 = True, n, n*2)</p> <p>IF(n &lt; 10, n, Log(n))</p>

## 8.1.5 Date and Time Functions

In MAS-3000, the date and time value of when a sample is taken is a floating-point number. The integer part of the number represents the date: it is the number of days since the first day of 1 AD. The fractional part of the number represents the time: it is the proportion of time that has passed since the beginning of the day.

Function	Meaning
Date( <i>year</i> , <i>month</i> , <i>day</i> )	<p>Return the date in MAS-3000 format e.g.</p> <p>Date(1999, 07, 25)</p>
Time( <i>hour</i> , <i>minute</i> , <i>second</i> , <i>ms</i> )	<p>Return the time in MAS-3000 format e.g.</p> <p>Time(16, 59, 31, 965)</p>
Elapsed( <i>sample number</i> )	<p>Return the date and time of the sample in MAS-3000 format e.g.</p> <p>DAT(36)</p>
SampleDate(n)	Date of the nth sample
SampleTime(n)	Time of the nth sample

## 8.2 OPERATORS

### 8.2.1 Logical Operators

Operator	Meaning
<	Less than
<=	Less than or equal to
<>	Not equal to
=	Equal to
>=	Greater than or equal to
>	Greater than

### 8.2.2 Arithmetic Operators

Operator	Meaning
+	Addition
-	Subtraction
/	Division
*	Multiplication

The order of precedence is as in standard arithmetic (i.e. /, \*, +, -). An operand between two operators of different precedence is bound to the operator with higher precedence. An operand between two equal operators is bound to the one on its left. Expressions within parentheses are evaluated before being treated as a single operand.